

Configurable Multi-Input Controller with time-proportioning

1/8 DIN - 48 x 96 mm

XE line

A compact, single loop controller with innovative features. Total configurability permits selection of input, outputs, alarms and operation modes directly from keyboard, thus allowing for maximum flexibility of use.

- **Accuracy:** 0,2
- **Input:** configurable (Pt 100, J, L, K, S, mA, Volt)
- **Control Mode:** On-Off or PID
- **Self-tuning:** for automatic adjustment of optimum control parameters
- **Main output:** configurable. Logic or relay, single or dual
- **Auxiliary output:** with relay, configurable
- **Indication:** simultaneous display of measurement and Set point
- **Access to parameters:** on 3 different levels for: modification, display only and no-access
- **Loop Break Alarm**
- **Single power supply:** 100...240 Vdc switching type, or 24 Vac and 24 Vdc

- **Auxiliary power supply for external transmitter:** 24 Vdc
- **Front protection:** IP54 standard, IP65 with optional front panel gasket
- **Front withdrawable**
- **Dimensions:** 48 x 96 DIN, depth 120

Options:

- **Serial communication**
- **2nd auxiliary output (extra):** with relay, configurable



E

Certified ISO 9001

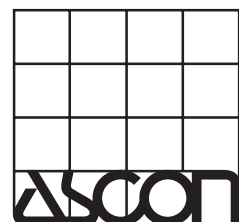

ASCON spa

20021 Bollate - (Milano) Italy - Via Falzarego, 9/11 - Tel. +39 02 333 371 - Fax +39 02 350 4243
<http://www.ascon.it> e-mail info@ascon.it

Configurable on field, easy to use, with serial communication. XE Series Controller

This new series of controllers with innovative features, oriented towards simple controls on machines and small industrial plants, is born from ASCON's wide experience combined with the use of the latest electronic technologies.

Total configurability from keyboard

This instrument is configurable from keyboard using a 5 figure code. Besides, it is very easy to reconfigure the controller on field to meet changing requirements. Configurability concerns the input type and scale range, output type either with relay or logic voltage, direct or reverse action, the safety state, the 2 auxiliary outputs.

Automatic tuning

For simple and quick optimisation of control parameters.

Serial communication

Configurable protocol and access to all controller parameters for working in a distributed control network.

Simple use

The most significant data appear clearly and completely on a "custom" display with different figure size and brightness for easy reading.

Maximum protection

High immunity to interferences, with guided procedures and 3 levels of access to control and operation parameters.

In short ...

Maximum flexibility of use, high performance/price ratio, drop in stock costs.



General description

INPUT

Suitable for use with usual temperature probes (thermocouples J, L, K, S, RTD Pt100), and normalised (mA or Volt) signals.

Input type, scale range, and full-scale values for configurable scales, can be configured from keyboard.

MAIN OUTPUT

The main output Y is time proportioning with relay (3A/250 Vac) or logic voltage (0/18 Vdc).

It may be single or dual (suitable for instance for heat/cool control), with direct or reverse action.

The above variants are simultaneously available.

AUXILIARY OUTPUTS

Auxiliary outputs Y2 and Y3 - Y3 is an option - are with relay (3A/250 Vac) and their actions are configurable from keyboard.

The action mode (active High/Low) and type of Set point (deviation, band, or independent) can be selected for each one.

Both outputs can also be configured as deviation alarm with "startup inhibition", to avoid undesirable actions in the starting phase.

LOOP BREAK ALARM

The auxiliary output Y3 may be used for "Loop Break Alarm" action to signal control loop failure or interruption.

Simultaneous flashing of all controller displays signals the alarm.

CONTROL

The 3 classical P, I, D actions are continuously adjustable within a wide range. They may be excluded to obtain a simple algorithm of type P, PD or PI, better suiting the features of the process to be controlled.

Setting a simple On-Off action with adjustable hysteresis is also possible.

AUTOMATIC TUNING

Automatic tuning for computation and automatic set of PID optimum parameters in the starting phase, or when the Set point is altered, or in normal conditions whenever deemed necessary by the operator. Enabled on the operator's request, it disconnects automatically at the end of the operation (One shot).

SERIAL COMMUNICATION

This is an option. It permits insertion of the controllers into a distributed control system: exchange of commands and information between instruments and a supervisor which may be a simple terminal or a process computer, is simple but efficient.

A traffic concentrator permits connection of up to 64 controllers to a single serial line of type RS232C, RS422A ou RS485, communicating with each one individually, thus creating a data transmission network permitting complete isolation of each instrument and guaranteeing service continuity, also in the event of some instruments being removed from their case.

CONFIGURATION

Configuration may be carried out via a serial line using a personal computer, or simply from the instrument front keyboard.

The configuration code is viewed on the measurement and Set point displays. If the instrument is not configured, the figures 9999 9999 appear, with direct access to configuration. If the instrument is already configured, the configuration indexes are shown on the display, and the secret code must be introduced in order to modify it.

ACCESS TO PARAMETERS

In order to avoid tampering by unauthorized staff, or inadvertent alterations of parameter values, these have been divided into homogeneous groups.

The "level of accessibility" can be configured for each group as follows:

1st level: visible and modifiable parameters

2nd level: visible but non-alterable parameters

3rd level: hidden and therefore non alterable parameters operating with the preset values but not appearing on call from keyboard.

Configurability of the level of accessibility, combined with a secret code (Password) makes the instrument safer and at the same time easier to use for the final operator, without limiting its programming power.

PROTECTION

All parameters and configuration values are stored in a non volatile memory for an unlimited period of time. In the parameter setting phase, the following can be established: upper and lower limits of the Set point, an upper limit for the main output, a standby value for the main output to be activated in case of input signal failure. Furthermore, circuit protections give this controller a degree of immunity to electrical disturbances higher than the maximum level (IV) considered by standard IEC 801-4 for heavy industrial environments.

Technical data

INPUT X

Common features

- A/D Converter: 50,000 points
- Measurement sampling time: 0.5 sec.
- Safety: measurement overshooting the scale range or a failure on the input line (interruption or short circuiting) is displayed and imposes on output Y1 the safety state pre-selected during the configuration phase.
- For variations from 100 to 240 Vac in line voltage, the measurement error is irrelevant.

Thermocouples

- Cold junction incorporated
- Line resistance: 150Ω max
- Measurement accuracy: 0.2% ± 1°C at 25°C ambient temp.
- Measurement drift: < 2μV/°C ambient temperature < 5μV/10Ω line resistance

RTD Pt100

- 2 or 3-wire connection
- Line resistance: 20Ω max for 3-wire connection
- Measurement accuracy: 0.2% at 25°C ambient temperature
- Measurement drift: < 0.1°C/10°C ambient temperature < 0.5°C/10Ω line resistance (3 wires)

DC current and voltage

- Input resistance: with current input: 15Ω with voltage input: 10kΩ
- Measurement accuracy: 0.1% at 25°C ambient temperature
- Measurement drift: < 0.1%/20°C ambient temperature

MAIN OUTPUT Y1

With Relay

1 NO contact 3A/250 Vac max rating

Logic voltage

0/18 Vdc ± 10%, 20 mA max, isolated, suitable for driving solid state relays.

Dual for Heat-Cool

An output Y3 with relay and NO contact 3A/250 Vac max is available for cool command

AUXILIARY OUTPUTS Y2, Y3

Actions Y2 and Y3 (see fig. 1)

For every action, the following can be configured:

- The control mode: Active high or Active low (that is relay energised above or under the threshold)
- The type of Set point (in respect of W1) Deviation: from -300 to +300 display steps Band: from 0 to 300 display steps Independent: within the scale span
- Output: 1 NO contact, isolated, 3A/250 Vac
- Hysteresis: 0.1 to 10% of scale span

Notes

- 1 - The setting range of Set points Y2 and Y3 is not limited by the limits of the main Set point W1, but only by the scale span.
- 2 - The operation of Y2 (Y3) configured as Deviation alarm with inhibited startup is illustrated in fig. 2.
- 3 - Y3 is an option.

CONTROL

The main control algorithm features PID, PI, PD, P action or On-Off.

Common parameters:

- Proportional band: 0.5 to 1000%
- Integral action time: 0.1 to 100 minutes, excludable. Outside the proportional band, the integral action is neutralized
- Derivative action time: 0.01 to 10 minutes, excludable
- Maximum output Y1: 10 to 100%
- Cycle time: 1 to 200 sec.

For On-Off control with hysteresis

- Hysteresis from 0.01 to 10%

For Heat/Cool

The P parameters, cycle time and maximum possible output can be set separately for the 2 Heat and Cool channels. The I, D parameters are the same for the 2 channels.

- Neutral zone between the two actions: 0,0 a 5% (see fig. 3)
- Maximum output Y3 Cold: -10 a -100%

Fig. 1: Y2 and Y3 auxiliary controls

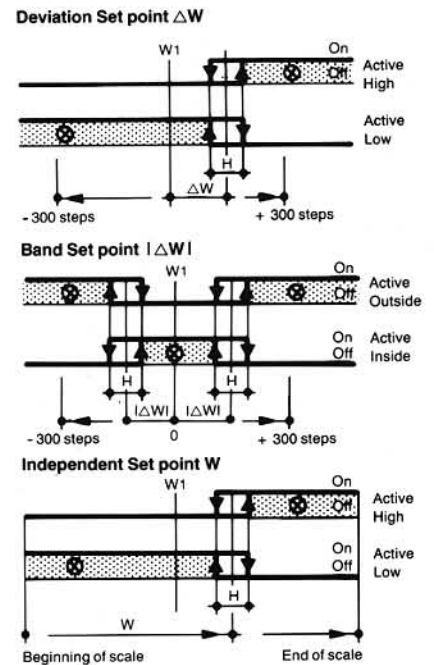

Fig. 2: Y2 and Y3 auxiliary controls with inhibited startup

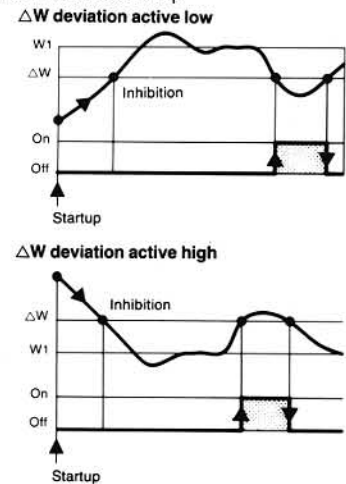
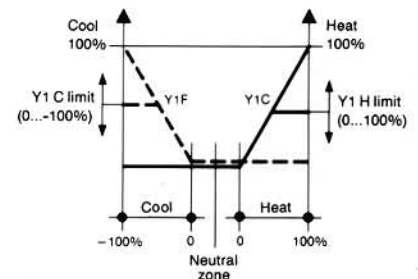

Fig. 3: Output characteristic for dual action controllers. Example Heat-Cool



Y1 C = Cool output (---)
Y1 H = Heat output (—)
Indication Y1: -100%...0...100%

Connections and overall dimensions

SET POINT

The Set point variation speed in passing from a value to another can be set (separately for ascent and descent) from 0.0 to 120% scale/minute or as a normal step change.

POWER SUPPLY FOR TRANSMITTER

- To supply a 2-wire 4...20 mA transmitter or a 3-wire 24 Vdc transmitter

SERIAL COMMUNICATION

- Passive 20 mA C.L. isolated interface
- ASCII code or Modbus/Jbus protocol
- Baud rate configurable between: 600, 1200, 2400, 4800 or 9600 (only Modbus/Jbus) Bit/s
- Interface with RS232C, RS422A, RS485 port via traffic concentrator ALS type (it's possible to connect up to 64 ASCON instruments, also of different type)

GENERAL DATA

- Power supply: 100...240 V, 50/60 Hz, -15 + 10% (250V max) or 16...28V, 50/60 Hz and 20...30 Vdc
- Isolation class: C according to VDE 0110
- Climatic group: KWF according to DIN 400400
- Ambient operating temperature: 0 to 50°C
- EMI suppression: Level IV to IEC 801-4 (for heavy conditions)
- Protection according to DIN 40050 front panel: IP54 case: IP20 terminal board: IP10 self-extinguishing material UL94 V1
- Weight: about 0.6 kg
- Dimensions: 48 x 96, depth 120 mm

CONNECTIONS

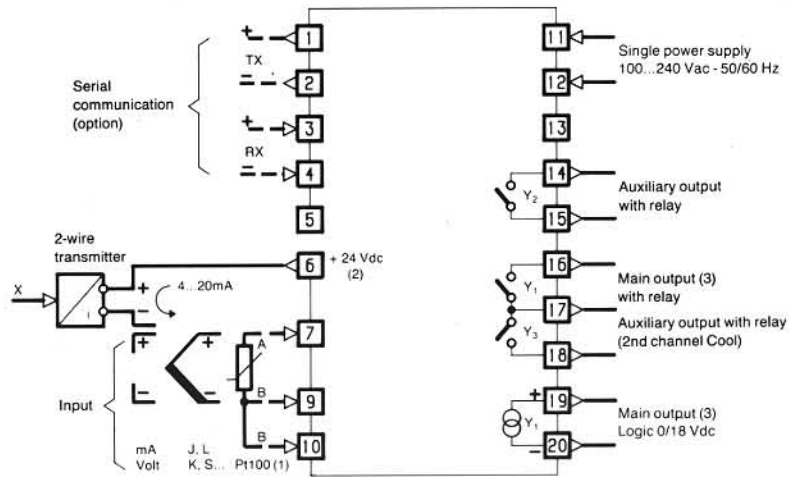

Notes:

- To connect a 2-wire RTD Pt100, link terminals 9 and 10
- To supply 3 or 4-wire transmitters, use terminals 6 (+) and 9 (-)
- The main output Y1 may be selected between the 2 variants simultaneously present: with Relay between terminals 16 and 17; Logic voltage between terminals 19 and 20.

DIMENSIONS

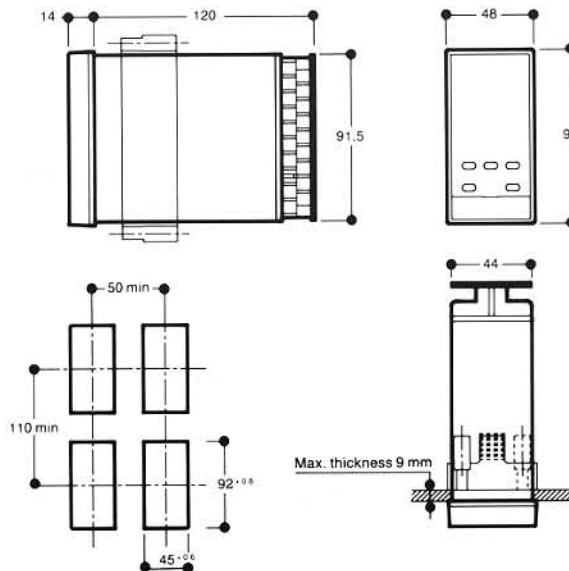

Models and configurations

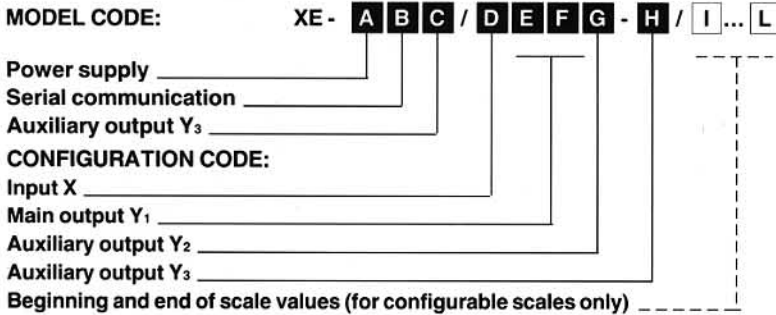

MODEL CODE:

Power supply	A
100...240 V 50/60 Hz	3
16...28 V 50/60 Hz and 20...30 Vdc	5

Serial communications	B
None	0
20 mA C.L. Ascon std. protocol	1
20 mA C.L. Modbus/Jbus protocol	2

Auxiliary output Y ₃	C
None	0
Fitted	1

CONFIGURATION CODE: (1)

Input type, scale range (2)			D
RTD IEC 751	Pt100	-200...600°C	0
	Pt100	-99.9...300.0°C	1
Thermocouples IEC 584	Type J	0...600°C	2
	Type L	0...600°C	3
	Type K	0...1200°C	4
	Type S	0...1600°C	5
4...20 mA	Conf. eng. units		6
0...20 mA	Conf. eng. units		7
0...1 Vdc	Conf. eng. units		8
0...10 Vdc	Conf. eng. units		9

Output type Y ₁ (3)	E
Relay (On-Off with hysteresis)	0
Relay with time proportioning	1
Logic 0/18 Vdc with time proportioning	2
Relay with time proportioning	* 6
Logic 0/18 V with time proportioning	* 7

Type of action and safety state Y ₁ (4)				F
Reverse	Safety	0%		0
Direct	Safety	0%		1
Reverse	Safety	100%		2
Direct	Safety	100%		3
Reverse	Safety	-100% *		4
Direct	Safety	-100% *		5

Type of Set point and control mode output Y ₂			G
Disabled			0
Deviation with startup inhibition	Active high		1
	Active low		2
Band	Active outside		3
	Active inside		4
Independent	Active high		5
	Active low		6
Deviation	Active high		7
	Active low		8
Loop - Break - Alarm			9

Type of Set point and control mode output Y ₃ (5)			H
Disabled			0
Deviation with startup inhibition	Active high		1
	Active low		2
Band	Active outside		3
	Active inside		4
Independent	Active high		5
	Active low		6
Deviation	Active high		7
	Active low		8
Heat Cool			9

Notes on configuration

- To receive a non-configured instrument, indicate code **9999 -9**.
- For mA and Volts inputs, the beginning and end of scale values can be configured in engineering units between -999 and 9999. The minimum scale span is 100 steps. The values can be expressed in units (xxxx), in tenths (xxx.x), hundredths (xx.xx), or thousandths (x.xxx). Lacking the indication of beginning and end of scale values, the instrument will be supplied with 0.0...100.0 scale.
- For Heat-Cool controllers, select outputs with * (**E-6**) or (**E-7**).
- The safety state is the value assumed by Y₁ in case of failure in the control loop. Actually, it is the value defining the upper limit of Y₁. The safety states with * (**F-4**) or (**F-5**) set the maximum limit to Cool.
- Excluding the output option Y₃ (**C-0**) implies selecting (**H-0**) in configuration.

Ordering examples:

XE-300/4107-0
defined configuration

XE-311/6109-7/- 50.0...150.0
configuration with scale range in engineering units

XE-310/9999-9
not configured

ACCESSORIES

● SERIAL COMMUNICATIONS INTERFACE for 64 ASCON instruments

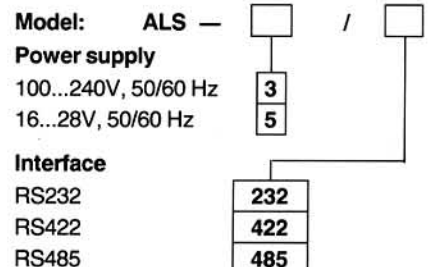

● FRONT PROTECTION KIT IP65: mod. F10-170-2A101