

Configurable Multi-Input, Multi-Output or Multi-Set point Controller

1/8 DIN - 48 x 96 mm

XS line

A single loop process controller with innovative features, thanks to total configurability permitting selection of: input, outputs, alarms and operation modes directly from keyboard.

- **Accuracy:** 0,2
- **Input:** universal configurable (Pt 100, J, L, K, S, R, mA, Volt). Configurable scale range
- **Logic inputs:** 3
- **Control mode:** PID with Feed-Forward action and approaches
- **Expert self-tuning:** One-shot Auto-tune for automatic adjustment of PID parameters. Expert-tune for continuous optimisation during working conditions
- **Auto/Manual Station:** built-in
- **Main output:** configurable, time-proportioning or continuous, single or dual
- **Auxiliary outputs:** 2 with relay, configurable
- **Loop Break Alarm**
- **Set point:** local, remote, multi-Set point (up to 4)
- **Access to parameters:** on 3

different levels for: modification, display only and no-access

- **Single power supply:** 100...240 Vac switching type, or 24 Vac and 24 Vdc
- **Auxiliary power supply for external transmitter:** 24 Vdc
- **Front protection:** IP54 standard, IP65 with optional front panel gasket
- **Front withdrawable**
- **Dimensions:** 48 x 96 DIN, depth 150

Options:

- **Serial communication**
- **Retransmission output:** 4...20 mA or 0...10 V analogue signal
- **Programmable Set point:** 1 programme storable up to 11 segments



E

Certified ISO 9001

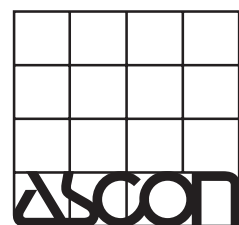

ASCON spa

20021 Bollate - (Milano) Italy - Via Falzarego, 9/11 - Tel. +39 02 333 371 - Fax +39 02 350 4243
<http://www.ascon.it> e-mail info@ascon.it

Multi-Input, Multi-Output, Multi-Set point with XS Series Controller

This new series of controllers with truly innovative features comes from ASCON's wide experience combined with the use of the latest electronic technology.

Total configurability from keyboard

All possible functions are simultaneously available in the instrument. Model and operation mode are selected according to the specific application through instrument configuration from the front keyboard or via a serial line with an eight figure code. Besides, it is very easy to reconfigure the controller on field to meet other requirements.

Total configurability concerns the input type and scale range, the main output type, action and safety state, the Set points, and the 3 auxiliary outputs.

Automatic tuning

Including: Auto-tune for rapid and easy parameter identification, and Expert-tune for continuous parameter optimisation during service.

Serial communication

Configurable protocol and access to all controller parameters for working in a distributed control network.

All types of Set points

The working Set point can be Local, Remote, Time programmed or can be selected among four stored ones, thus increasing automation level.

Simple use

The most significant data appear clearly and completely on a "custom" display with different figure size and brightness for easy reading.

Maximum protection

High immunity to interferences, guided procedures and 3 different levels of access to control and operation parameters.

In short ...

Maximum flexibility of use, high performance/price ratio, drop in stock costs.



Single power supply
100 to 240 Vac

IP 54 or IP 65
Front protection

Display of
measurement or
parameter values

Display of Set point or
mnemonic parameter
codes

Auto-tune in course

Manual operation

Main output display

Main output "On"

Keyboard

Extraction screw

Remote Set point
activated

Serial communication
activated

Stored programme in
course of execution

N° of the called
Set point
N° of the segment in
execution

Standby of
programme in
execution

Auxiliary output Y3
"On"

Auxiliary output Y2
"On"

Model code plate

General description

INPUT

Suitable for use with most common temperature probes (thermocouples J, L, K, S, R), resistance thermometers (Pt 100), as well as for normalised current (mA) or voltage (V) signals. Input type, scale range and full-scale values can be programmed using the front panel keys.

LOGIC INPUTS

According to the adopted configuration, 3 logic inputs can alter the controller modes of operation by means of external commands. For instance: Automatic-Manual transfer, Local-Remote Set point switching, recalling a stored Set point, handling a stored programme (launching, temporary waiting, resetting).

MAIN OUTPUT

The main output Y1 is galvanically isolated. It is either single or dual (useful for instance in heat/cool controls), time-proportioning or continuous and with direct or reverse action. Its type can be selected among the 4 variants simultaneously present: with relay (5A/250 Vac), logic voltage (0/18 Vdc), DC voltage (0...10 Vdc), DC current (4...20 mAdc).

AUXILIARY OUTPUTS

Auxiliary outputs Y2 and Y3 are with relay (5A/250 Vac) and their actions are configurable from keyboard. The action mode (Active High/Active Low) and type of Set point (deviation, band or independent) can be selected for both outputs. With the "programmable Set point option", the 2 auxiliary outputs may be associated with the Set point, as logic outputs associated to the time-programmed Set point profile. Both can also be configured as deviation alarm with "startup inhibition", to avoid undesirable actions in the starting phase.

LOOP BREAK ALARM

To signal failure or interruption of the control loop, auxiliary output Y3 may be used for "Loop Break Alarm" action. Simultaneous flashing of all controller displays signals the alarm.

RETRANSMISSION OUTPUT

In option for input measurement or Set point retransmission, or as 2nd output channel for controllers with a dual main output. Galvanically isolated.

CONTROL

In critical operating conditions, the 3 actions P, I and D are backed up by an approach algorithm (Approach High and Low) and predictive (Feed-Forward) action in order to improve the response in case of large Set point changes or in presence of strong disturbances on the process.

AUTOMATIC TUNING

The Automatic tuning for computation and automatic set of PID optimum parameters operates in two distinct ways. Auto-tune identifies the parameters in open loop in the starting phase, or when the Set point is modified, or in normal conditions whenever deemed advisable by the operator. Enabled on the operator's request, it is automatically disconnected at the end of the operation (One shot). The Expert-tune continually analyzes the closed loop response, in order to re-tune the parameters during working conditions. It operates in case of Set point deviation higher than 1%. Enabled by the operator, it remains active until disabled.

SET POINT

The instrument can operate with either a local or remote Set point, or with a Set point selected out of 4 stored ones, that can be recalled either from keyboard or through external contact, using the logic inputs. An execution optionally supplied allows the instrument to operate with a local Set point or a time-programmable Set point with 11 segments.

This last option permits to program the number of cycle repetitions as well as the maximum deviation allowed during the dwell segment, in order to guarantee that the time spent at the required Set point is as programmed. Launching and temporary or final halting of programme execution are effected from the keyboard or through external controls. In any case, the passage from a Set point value to another can take place with a pre-settable gradient, distinct for ascent and descent.

SERIAL COMMUNICATIONS

This is an option. It permits insertion of the controllers into a distributed control system: the exchange of commands and information between instruments and a supervisor which may be a simple terminal or a process computer, is simple but efficient.

A traffic concentrator permits connection of up to 64 controllers with a single serial line of type RS232C, RS422A and RS485, communicating with each one individually, thus creating a data transmission network permitting complete isolation of each instrument and guaranteeing service continuity, also in the event of some instruments being removed from their case.

CONFIGURATION

Configuration may be carried out via a serial line using a personal computer, or simply from the instrument front keyboard.

The configuration code is viewed on the measurement and Set point displays. If the instrument is not configured, the figures 9999 9999 appear, with direct access to configuration. If the instrument is already configured, the 8 configuration indexes are shown on the displays, and the secret code must be introduced in order to modify it.

ACCESS TO PARAMETERS

In order to avoid tampering by unauthorized staff, or inadvertent alterations of parameter values, these have been divided into homogeneous groups. The "level of accessibility" can be configured for each group as follows:

Technical data

- 1st level: visible and modifiable parameters
- 2nd level: visible but non-alterable parameters
- 3rd level: hidden and therefore non-alterable parameters operating with the preset values but not appearing on call from keyboard.

Configurability of the level of accessibility, combined with a secret code (Password) makes the instrument safer and at the same time easier to use for the final operator, without limiting its programming power.

PROTECTION

All parameters and configuration values are stored in a non-volatile memory for an unlimited period of time. In the parameter setting phase, the following can be established: upper and lower limits of the Set point, an upper limit for the main output, a safety value for the main output to be activated in case of input signal failure. Furthermore, circuit protections give this controller a degree of immunity to electrical disturbances higher than the maximum level (IV) considered by standard IEC 801-4 for heavy industrial environments.

INPUT X

Common features

- A/D Converter: 50,000 points
- Measurement sampling time: 0.5 sec.
- Safety: a measurement overshooting the scale range or a failure on the input line (interruption or short circuiting) is displayed and imposes on output Y1 the safety state pre-selected during the configuration phase.
- For variations from 100 to 240 Vac in line voltage, the measurement error is irrelevant.

Thermocouples

- Cold junction incorporated
- Line resistance: 150Ω max
- Measurement accuracy: 0.2% ± 1°C at 25°C ambient temp.
- Measurement drift: < 2μV/°C ambient temperature < 5μV/10Ω line resistance

RTD Pt100

- 2 or 3-wire connection
- Line resistance: 20Ω max for 3-wire connection
- Measurement accuracy: 0.2% at 25°C ambient temp.
- Measurement drift: < 0.1°C/10°C ambient temp. < 0.5°C/10Ω line resistance (3 wires)

DC current and voltage

- Input resistance: with current input: 15Ω with voltage input: 10kΩ
- Measurement accuracy: 0.1% at 25°C ambient temp.
- Measurement drift: < 0.1%/20°C ambient temp.

MAIN OUTPUT Y1

With relay

1 NO contact 5A/250 Vac max rating.

Logic voltage

0/18 Vdc ± 10%, 20 mA max, isolated, suitable for driving solid state relays.

DC current

4...20 mA isolated, 500Ω max (10V max)

DC voltage

0...10 V, isolated, 500Ω min (20 mA max)
Protected against short circuits.

Dual Y1

For processes with "dual action" output Y1 (for instance Heat/Cool), an

extra output Y1 is available, with relay and 1 NO contact 5A/250 Vac max. Possible combinations for dual Y1:

Y1 Heat	R	L	L	R	C	R	C	L	C
Y1 Cool	R	R	L*	L*	R	C	C	C	L*

R = Relay; L = Logic;
C = Continuous (mA or Volt);
* version on request

For Y1 Cool, R is the extra relay of Y1, while C is the retransmission output Y4 configured to retransmit Y1 cool: 4...20 mA or 0...10 Volt.

AUXILIARY OUTPUTS Y2, Y3 and Y4

Actions Y2 and Y3 (see fig. 1)

For every action, the following can be configured:

- The control mode: Active high or Active low (that is relay energised above or under the threshold)
- The type of Set point (in respect of W1)
Deviation: from -300 to +300 display steps
Band: from 0 to 300 display steps
Independent: within the scale span
- Output: 1 NO contact, isolated, 5A/250 Vac
- Hysteresis: 0.1 to 10% of scale span

Fig. 1: Auxiliary controls Y2 and Y3

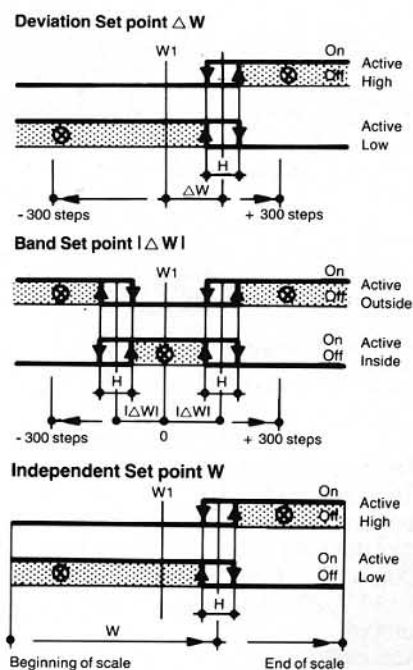

Note:
W1: Main Set point
H: Auxiliary control hysteresis

Notes

1 - The setting range of Set points Y2 and Y3 is not limited by the limits of the main Set point W1, but only by the scale span.

2 - The operation of Y2 and/or Y3 configured as Deviation alarm with inhibited startup is illustrated in fig. 2.

Fig. 2: Auxiliary controls Y2 and Y3 with inhibited startup

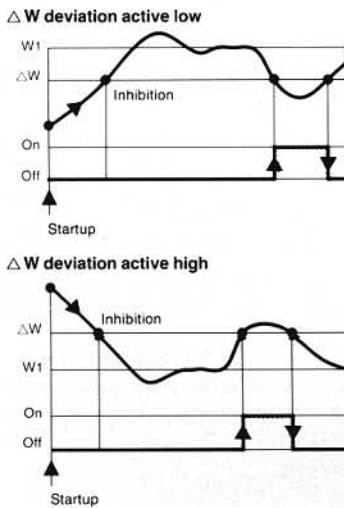
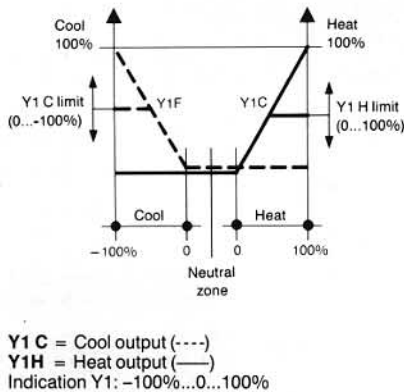

Fig. 3: Output characteristic for dual action controllers. Example: Heat-Cool



Retransmission output Y4

- Retransmitted signal: measurement X, Set point W1 or Y1 cool (for Heat-Cool controller only)
- Output: 4...20 mA, 10 V max or 0...10 V, 20 mA max by means of a jumper
- Accuracy: 0.1% at 25°C ambient temp.
- Resolution: 12 bits (0.025%)
- Isolation: 500 Vac/1' in respect of input

CONTROL

The main control algorithm features PID, PI, PD, P action or On-Off.

Common parameters:

- Proportional band: 0.5 to 1000%
- Integral action time: 0.1 to 100 minutes, excludable. Outside the proportional band, the integral action is neutralised.
- Derivative action time: 0.01 to 10 minutes, excludable
- Maximum output Y1: 10 to 100% for the 1st channel -10 to -100% for the 2nd channel (cool)
- Feed-Forward action: 0 to 500% Y1/scale span, excludable
- High and low approaches: 0.01 to twice the proportional band

For time-proportioning controls

- Cycle time: 1 to 200 sec.

For On-Off controls with hysteresis

- Hysteresis: 0.1 to 10%

For Heat/Cool

The P,I,D parameters, cycle time and maximum possible output can be set separately for the 2 channels.

- Neutral zone between the two actions: 0,0 to 5% of Y1 (see fig. 3).

SET POINT

The Set point variation speed in passing from a value to another can be set (separately for ascent and descent) from 0,0 to 120% scale/minute or as a normal step change.

Remote Set point

- Input: 4...20 mA on 15Ω or 0...10 V on 330kΩ
- Accuracy: 0.1% at 25°C ambient temp.
- Resolution: 50,000 points
- Not galvanically isolated from the main input

Stored Set points

- Up to 4 retrievable values

Programmable Set point (see fig. 4)

- Number of segments: 3 to 11, including 1 initial and 1 final segment
- Number of repetitions: 1 to 9999 or continuous repetitions
- The following can be set for every single segment:
 - Duration: 0.1 to 540 minutes (std)
 - 1 to 9999 minutes (request)
 - Final segment value
 - State of Y2 and Y3 logic outputs
 - Maximum dev.: 0,1 to 100% of scale

Fig. 4: Example of Programmed Set point

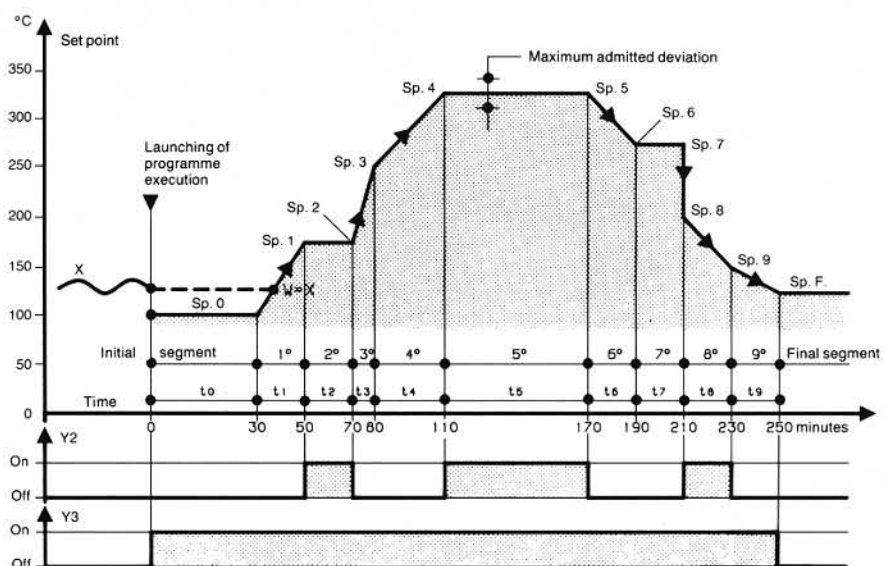

Notes:

- With duration of initial segment to = 0, execution begins from segment 1 with W = X
- With a deviation higher than the maximum one set, time count stops in order to guarantee scheduled durations.

Connections and overall dimensions

AUTO/MAN STATION

- Built-in with Bumpless action
- AUTO/MAN transfer via keyboard, logic input and serial

POWER SUPPLY FOR TRANSMITTER

- To supply a 2-wire 4...20 mA transmitter or a 3-wire 24 Vdc transmitter

SERIAL COMMUNICATIONS

- Passive isolated interface
- ASCII code
- Baud rate configurable between: 600, 1200, 3400, 4800 or 9600 (only for Modbus/Jbus) Bit/s
- Interface with RS232C, RS422A, RS485 port via traffic concentrator ALS type (it's possible to connect up to 64 ASCON instruments, also of different type)

GENERAL DATA

- Power supply: 100...240 V, 50/60 Hz, -15 + 10% (250V max) or 16...28V, 50/60 Hz and 20...30 Vdc
Power consumption: 4 VA max
- Isolation class: C according to VDE 0110
- Climatic group: KWF according to DIN 40040
- Ambient operating temperature: 0 to 50°C
- EMI suppression: Level IV to IEC 801-4 (for heavy conditions)
- Protection according to DIN40050 front panel: IP54 housing: IP30 terminal board: IP20 self-extinguishing material UL94V1
- Weight: about 0.6 kg
- Dimensions: 48 x 96, depth 150 mm

CONNECTIONS

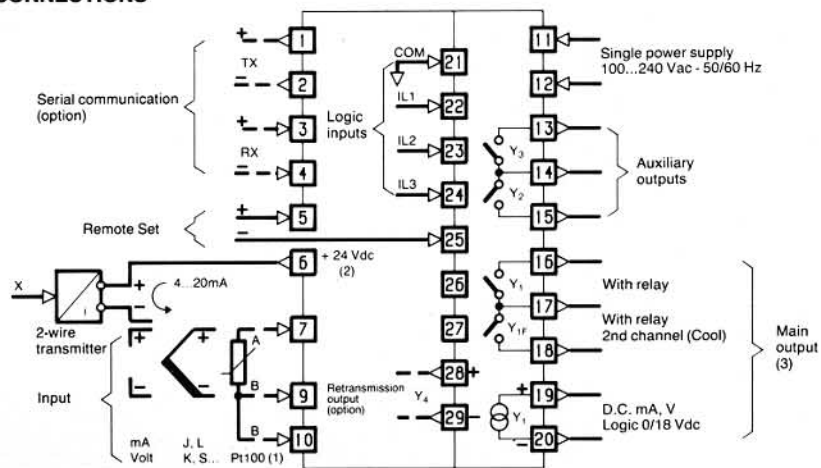

Notes:

- 1 To connect a 2-wire RTD Pt100, link terminals 9 and 10
- 2 To supply 3 or 4-wire transmitter, use terminals 6 (+) and 9 (-)
- 3 Main output Y1 can be selected among the 4 functions simultaneously present: with relay between terminals 16 and 17; Logic voltage 0/18 Vdc or 4...20 mA or 0...10 Vdc: between terminals 19 and 20

OVERALL DIMENSIONS

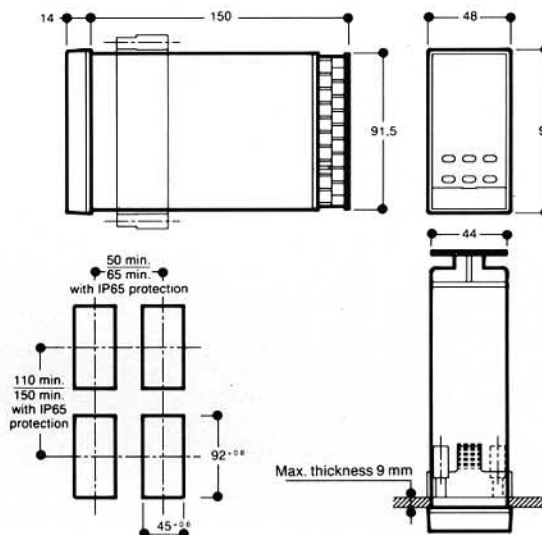

ACCESSORIES

- SERIAL COMMUNICATIONS INTERFACE for 64 ASCON instruments

Model:

ALS — □ / □

Power supply

100...240V, 50/60 Hz
16...28V, 50/60 Hz

Interface

RS232
RS422
RS485

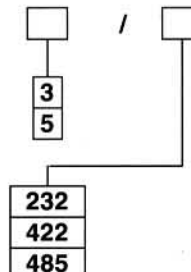

- FRONT PROTECTION KIT IP65: mod. F10-170-2A101

Models and configurations

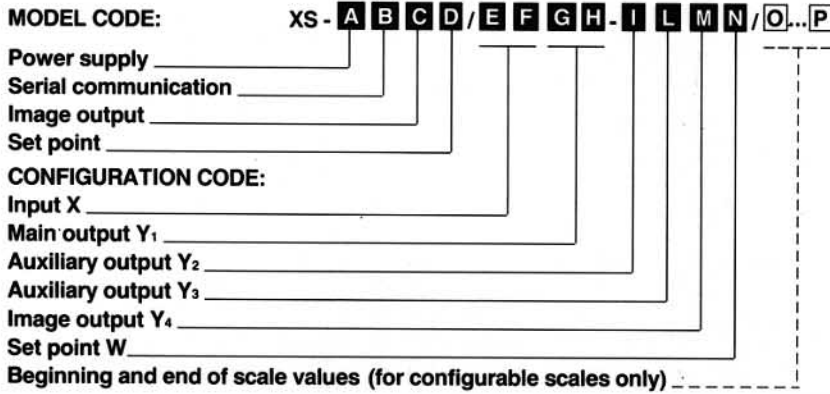

MODEL CODE:	
Power supply	A
100...240 V 50/60 Hz	3
16...28 V 50/60 Hz and 20...30 Vdc	5
Serial communications	B
None	0
20 mA C.L. Ascon std. protocol	1
20 mA C.L. Modbus/Jbus protocol	2

Retransmission output Y₄	C
None	0
Fitted (4...20 mA or 0...10 Vdc)	1
Set point	D
Standard (up to 4 mem. or Loc./Rem.)	0
Time-programmable (11 segments)	1

CONFIGURATION CODE: (1)		Input type, scale range (2)		E	F
RTD	-200...600°C	0	0		
	Conf. -200...600°C	0	2		
Pt100Ω IEC 751	-99.9...300.0°C	1	0		
	Conf. -99.9...300.0°C	1	2		
Thermocouple J Fe-Cu 45%Ni IEC 584	0...600°C	2	0		
	Conf. within 0...600°C	2	2		
Thermocouple L Fe-Const DIN 43710	0...600°C	3	0		
	Conf. 0...600°C	3	2		
Thermocouple K Chromel-Alumel IEC 584	0...1200°C	4	0		
	Conf. 0...1200°C	4	2		
Thermocouple S Pt10%RhPt IEC 584	0...1600°C	5	0		
	Conf. 0...1600°C	5	2		
Thermocouple R Pt13%RhPt IEC 584	0...1600°C	6	0		
	Conf. 0...1600°C	6	2		
4...20 mA	Conf. eng. units	7	4		
0...20 mA	Conf. eng. units	7	5		
0...1 Vdc	Conf. eng. units	7	6		
0...10 Vdc	Conf. eng. units	7	7		

Type of output Y₁ (3)	G
Relay (On-Off with hysteresis)	0
Relay with time-proportioning	1
Logic 0/18 Vdc with time-proportioning	2
4...20 mAdc	3
0...10 Vdc	4
Time-proportioning relay	* 6
Time-proportioning Logic Voltage 0/18 Vdc	* 7
4...20 mAdc	* 8
0...10 Vdc	* 9

Type of action and safety state Y ₁ (4)				H
Reverse	Safety	0%	0%	0
Direct	Safety	0%	0%	1
Reverse	Safety	100%	100%	2
Direct	Safety	100%	100%	3
Reverse	Safety	-100% *	-100% *	4
Direct	Safety	-100% *	-100% *	5

Type of Set point and control mode output Y ₂ (I)			I
Disabled			0
Deviation with startup inhibition	Active high		1
	Active low		2
Band	Active outside		3
	Active inside		4
Independent	Active high		5
	Active low		6
Deviation	Active high		7
	Active low		8
Time programmable (5)			9

Type of Set point and control mode output Y ₃ (L)			L
Disabled			0
Deviation with startup inhibition	Active high		1
	Active low		2
Band	Active outside		3
	Active inside		4
Independent	Active high		5
	Active low		6
Deviation	Active high		7
	Active low		8
Loop - Break - Alarm			9
Time programmable (6)		*	9

Retransmission output Y ₄		M
None (7)		0
4...20 mA	Retransmission measurement X	1
	Retransmission Set point W	2
	Retransmission Y ₁ Cool (8)	3
0...10 Vdc	Retransmission measurement X	4
	Retransmission Set point W	5
	Retransmission Y ₁ Cool (8)	6

Type of Set point		N
Standard	1 Local + 4 stored	0
	1 Local and Remote 4...20 mA	1
Time programmable (9)	1 Local and Remote 0...10 Vdc	2
		3

Notes for configuration

1 - To receive a non-configured instrument, indicate code **9999 - 9999**.

2 - For Pt100 and thermocouple inputs with configurable scale, it is advised to select significant and round figure scale ranges (-50...150°C, 0...400°C). The minimum span should not be less than 25% of the maximum range. Keep in mind that, within the selected range, it is possible to limit the setting interval of the Set point between the lower and upper value.

For mA and Volts inputs, the beginning and end of scale values can be configured in engineering units between -999 and 9999. The minimum scale span is 100 steps.

The values can be expressed in units (xxxx), in tenths (xxx.x), hundredths (xx.xx), or thousandths (x.xxx).

Lacking the indication of beginning and end of scale values, the instrument will be supplied with 0.0...100.0 scale.

3 - In order to select some types of output, it is also necessary to set a switch placed inside the instrument.

For heat-cool control, select the outputs with * from (G-6) to (G-9).

4 - The safety state is the value assumed by Y1 in case of failure in the control loop. Actually, it is the value defining the upper limit of Y1. Safety states with * (H-4) or (H-5) impose the maximum limit to Cool action.

5 - The time-programmable logic output (I-9) is only possible with the programmable Set point option (D-1).

6 - Only available with the programmable Set point option (D-1). Replaces the Loop-Break-Alarm function.

7 - Excluding the retransmission output option (C-0) implies selecting (M-0) in configuration.

8 - The retransmission of Y1 Cool (M-3) and (M-6) is used, for instance, for driving a modulating valve.

Passing from 4...20 mA to 0...10 V is obtained also by moving a jumper inside the instrument.

9 - The programmable Set point option (D-1) implies selecting (N-3) in configuration.

Ordering examples:

XS-3100/4010-8700
configuration with defined scale range

XS-3011/7430-5913/-50.0...150.0
configuration with scale range in engineering units

XS-3100/9999-9999
not configured