

insertion

vortex

flowmeter

Model V-Bar General Specification

V-Bar-600/60S

V-Bar-700

V-Bar-800/80S

V-Bar-910/960

Features

- ▶ Fluid types:
liquid, gas or steam
- ▶ Pipe sizes: 3 to 80 in.
(80 to 2000 mm)
- ▶ Rugged construction
- ▶ Reliability:
no moving parts
- ▶ Process pressure up to
2000 psig (138 barg)
- ▶ Process temperatures
up to 500 °F (260 °C)
- ▶ Industry standard
frequency and/or 4–20 mA
output signals
- ▶ Optional integral pressure
and/or temperature
measurement
- ▶ Negligible head loss
- ▶ Compatible with HART®
protocol
- ▶ EZ-Logic™ menu-driven
user interface
(microprocessor-based)
- ▶ Local programming via
EZ-Logic keypad or
magnet wand through
explosion-proof enclosure

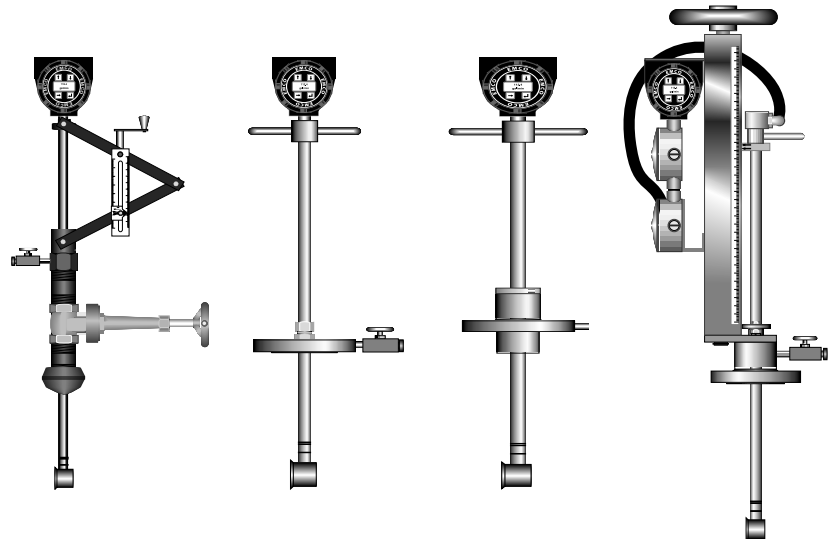

EMCO's model V-Bar™ Insertion Vortex Flowmeters measure flow rates for a wide variety of fluids and pipe sizes. Unlike an inline flowmeter, which replaces a section of pipe, an insertion meter is “tapped” into the flow line and can be mounted virtually anywhere.

EMCO's V-Bar insertion flowmeters have three main components: the retractor, the sensor, and the electronics. The retractor serves to position the sensor within the pipe. The sensor detects the pattern of vortices as a frequency signal. The “Smart,” microprocessor-based EZ-Logic electronics conditions the signal and provides a frequency output, a scaled pulse output, or a 4–20 mA dc signal proportional to the average pipe flow rate.

Most V-Bar flowmeters can be installed on an isolation valve, which permits installation and removal without process shutdown. Integral pressure and/or temperature measurement may be combined with the V-Bar to provide mass flow measurement from a single pipe tap. In addition, a flow processor may be used to increase the accuracy and functionality of the metering system.



Engineering Measurements Company

303.651.0550 • 303.678.7152 Fax
sales@emcoflow.com



Application Guide

Model	Liquid	Gas	Steam	Hot Tap	Temperature Range		Maximum Pressure ¹		Seal Type	Line Sizes	
					°F	°C	psi	bar		in.	mm
600	yes	yes	no	yes	-40 to 400	-40 to 204	125	8.62	Viton™	3 to 80	80 to 2000
60S	no	no	yes	yes	-65 to 400	-54 to 204	125	8.62	E/P ²	3 to 80	80 to 2000
700	yes	yes	yes	no	-200 to 600	-129 to 316	2000 ³	138 ⁴	Swagelok™	3 to 80	80 to 2000
800	yes	yes	no	yes	-40 to 400	-40 to 204	50	3.45	Viton™	3 to 80	80 to 2000
80S	no	no	yes	yes	-65 to 400	-54 to 204	50	3.45	E/P ²	3 to 80	80 to 2000
910	yes	yes	yes	yes	-200 to 400	-129 to 204	flange rating		Teflon™	3 to 80	80 to 2000
960	yes	yes	yes	yes	-200 to 750	-129 to 400	flange rating		Grafoil™	3 to 80	80 to 2000

1. Maximum pressure at maximum temperature with appropriate connection.
2. Ethylene-Propylene elastomer.

3. Rating listed is for NPT connection. For flange connections, use ANSI flange rating.
4. Procedure 980318 has PSI-2160 and Bar-149.

Performance Specifications

Accuracy (linear ranges)

Liquid±1.0% of flow rate
 Test conditions: Water at 60 °F (15 °C), 50 psig (3.4 barg) with a flow rectifier and 10 pipe diameters upstream.
 Gas and Steam±1.5% of flow rate
 Test conditions: Air at 68 °F (20 °C), 2 psia (2 bara) with a flow rectifier and 10 pipe diameters upstream.

Analog Outputadd ±0.1% of full scale

Repeatability

±0.15% of flow rate

Response Time

Adjustable from 1 to 100 seconds

Operating Specifications

Linear Range

Reynolds number from 20,000 to 7,000,000

Measurable Flow Velocities

Liquid Flow	English	Metric
V_{min}	1.5 ft/s	0.5 m/s
V_{max}	32 ft/s	9 m/s
Gas and Steam Flow	English	Metric
V_{min}	$\sqrt{\frac{50}{\rho}}$ ft/s	$\sqrt{\frac{74}{\rho}}$ m/s
V_{max}	300 ft/s	91 m/s
where:	ρ = density (lb/ft ³)	ρ = density (kg/m ³)

Operating Range

Use the following equations to determine the average fluid velocity within the pipe.

Average Fluid Velocity		
Fluid	English	Metric
Liquid	$0.4085 \frac{Q_1}{D^2}$	$353.7 \frac{Q_1}{D^2}$
Gas	$3.056 \frac{Q_2}{D^2}$	$353.7 \frac{Q_2}{D^2}$
Steam	$0.051 \frac{M}{\rho \cdot D^2}$	$353.7 \frac{M}{\rho \cdot D^2}$
Where:		
V = average fluid velocity	ft/s	m/s
D = pipe inside diameter	in.	mm
Q ₁ = liquid volumetric flow	gal/min	m ³ /h
Q ₂ = gas actual volumetric flow	ft ³ /min	m ³ /h
M = mass flow rate	lb/h	kg/h
ρ = fluid density	lb/ft ³	kg/m ³

Gas Flow Operating Range:

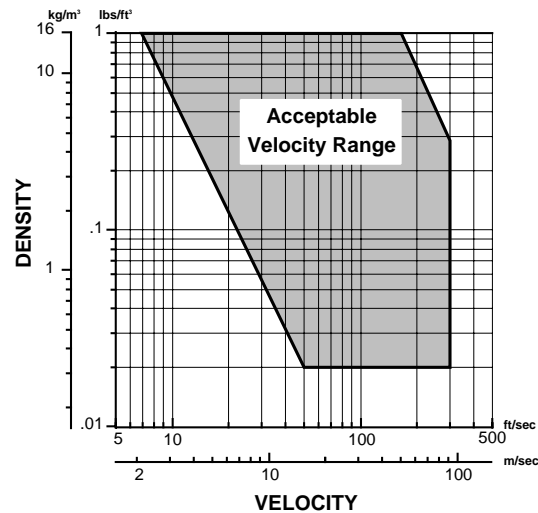

Process Viscosity

Reynolds number must be > 20,000. The figure below translates the minimum Reynolds number, 20,000, to the minimum measurable pipe velocity.

$$\text{Kinematic Viscosity } \nu = \frac{\mu \text{ (cP)}}{\text{S.G.}}$$

$$\text{Re} = \frac{124\rho VD}{\mu}$$

where ρ = fluid density
 V = average velocity (lb/ft³)
 D = pipe inside diameter (in.)
 μ = fluid viscosity (cP)
 S.G. = specific gravity

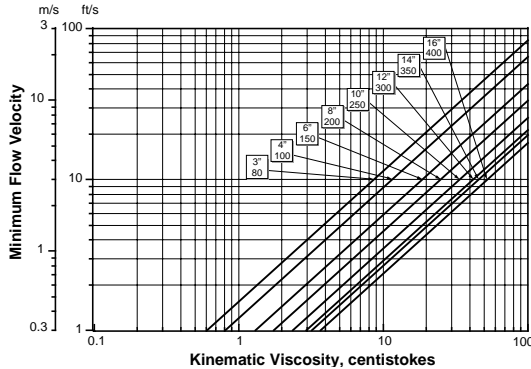

Ambient Temperature Limit

32 to 140 °F (0 to 60 °C)

Ambient Humidity Limit

5 to 100% relative humidity non-condensing

Power Requirements

Standard

Isolated 18–40 VDC, 35 mA maximum.

Note: Maximum voltage with pressure transmitter option is 30 volts.

Optional

110/220 VAC

NOTE: All power wiring must be enclosed in rigid conduit and a watertight and/or explosion proof seal applied at the conduit entry.

Output Signals

Analog

4–20 mA, 2-wire system, digitally adjusted span

Frequency

Voltage pulses, 3-wire system, 0 to 3000 Hz square wave, 50% duty cycle.

- Low Level: 0 to 1 volts
- High Level: power supply voltage-load

Pulse

3 wire system. Output can be scaled so that 1 pulse indicates a specific quantity of fluid passing through the pipe.

Hart® communications protocol

Display (LOC-TOT)

2-line by 8-character LCD digital display alternately show flow rate and totalized flow in user-selectable engineering units.

Four buttons (up, down, right, enter) operable either directly on the display panel or with a hand-held magnetic wand through the explosion-proof enclosure enable local programming. Local programming follows the EZ-Logic menu-driven user interface, which is the standard interface for EMCO flowmeter instrumentation.

Zero & Span Setting (analog output only)

Zero and span calibration can be performed without a frequency source by programming the flow rate using the EZ-Logic interface.

Physical Specifications

Materials

Wetted Parts

316L stainless steel or the cast equivalent, CF3M (bronze & carbon steel on V-Bar-600/60S)

External Parts

Aluminum, 316 stainless steel, carbon steel (bronze & carbon steel on V-Bar-600/60S)

Electrical Enclosure

383 Aluminum. Approved for NEMA 4X watertight and dusttight requirements.

Retractor Type

V-Bar-600/60S.....Screw thread, rising stem
V-Bar-700Not retractable
V-Bar-800/80S.....Manual rising stem
V-Bar-910/960Acme thread, non-rising

Process Connection

V-Bar-600/60S.....2" NPT
V-Bar-7002" NPT or
.....2" 150#, 300#, 600# or 900# ANSI
.....raised face flange
V-Bar-800/80S.....2" NPT or
.....2" 150# ANSI raised face flange
V-Bar-910/9602" 150#, 300#, 600# or 900# ANSI
..... raised face flange

Isolation Valve (V-Bar-600/60S only)

2" full port bronze gate valve, 125 psi (8.62 bar) maximum. For V-Bar-800/80S and V-Bar-910/960, see Accessories.

Pressure Tap and Bleed Valve

Standard 1/4" NPT pipe nipple with 1/4" stainless steel bleed valve (bleed valve is bronze for V-Bar-600/60S only). Provides connections for mounting optional pressure transmitter (Model PT).

Model PT Pressure Transmitter (Optional)

A pressure transmitter can be mounted using the 1/4" NPT connection on the bleed valve supplied with the meter, eliminating the need for a separate pressure tap. A 4–20 mA output, scaled to the desired pressure range, is provided.

All pressure transmitters include a siphon tube, bleed valve, plug, nipple, and tee. A pressure transmitter is not available with 110/220 VAC power. See the PT General Specifications for complete details.

Temperature Sensor (RTD Option)

A 1000 , 2-wire, platinum RTD can be mounted inside the stem of the flowmeter probe, eliminating the need for a separate temperature tap.

Temperature Transmitter (TXX Option)

Includes the RTD option with an additional 4–20 mA output, scaled to the desired temperature range. A temperature transmitter is not available with 110/220 VAC power.

Remote Mount Electronics (RMT Option)

30 ft (9.144 m) signal cable and U-bolts are provided with remote mount electronics. Cable must be run in conduit (conduit not supplied). Conduit connection is 3/4" NPT (PG 13.5).

Approvals

FM Approval (FM Option)

Certified by FM for Class I, Division 2, Groups A, B, C and D; Class II, III, Division 2, Groups F and G. FM option is not available when using a 4-20 mA temperature transmitter or a 110/220 VAC power supply option. Use the RTD option only for temperature selection, if FM is required.

CSA Approval (CSA Option)

Certified by CSA for Hazardous Locations Class I, Division 2, Groups A, B, C and D; Class II, Division 2, Groups F and G; Class III. CSA option is not available when using a 4-20 mA temperature transmitter or a 110/220 VAC power supply option. Use the RTD option only for temperature selection, if CSA is required. Pressure transmitter 0–1000 psig or with special scaling not FM or CSA.

European CE Mark

European CE mark when used without a 4-20 mA temperature output.

Accessories

Gate Valve (Model 2GV) (For use with V-Bar-800/80S and V-Bar-910/960 only)

Installation with a 2" double flanged, raised-face, full port gate valve enables the flow sensor to be inserted and removed from the pipe under full flow conditions. Both the valve and pipe tap must have a minimum 1.875 in. (48 mm) internal diameter clearance.

Flow Rectifier (Model EFR)

A flow rectifier (EFR) is recommended when there is insufficient straight pipe run or flow disturbance. When using

an EFR, the straight pipe run can be a combination of 5 pipe diameters upstream and 2 pipe diameters downstream, instead of the standard 10 and 5.

Flow Processors (Models FP-93 and FP-100)

A microprocessor-based flow processor can be used to significantly increase the accuracy and functionality of any flowmetering application. See the FP-93 or FP-100 General Specifications for complete details.

Measurable Flow Rates

Water Minimum and Maximum Flow Rates ¹							
in. (mm)	3 (80)	4 (100)	6 (150)	8 (200)	12 (300)	16 (400)	24 (600)
gpm	35 737	60 1,270	135 2,882	234 4,990	523 11,164	826 17,625	1,879 40,096
m ³ /h	2 46	2 80	9 182	15 315	33 704	52 1,112	119 2,530

1. Standard conditions of 60 °F (15 °C) and 14.7 psia (1.013 bar) in schedule 40 pipe.

Air Minimum and Maximum Flow Rates (SCFM ¹)							
Pressure ² (Density) ³	3"	4"	6"	8"	12"	16"	24"
0 (0.0764)	79 924	136 1,591	308 3,611	533 6,253	1,193 13,991	1,883 22,089	4,284 50,250
50 (0.3368)	165 4,073	285 7,015	646 15,916	1,119 27,561	2,504 61,665	3,954 97,355	8,995 221,469
100 (0.5979)	220 7,229	380 12,452	861 28,253	1,491 48,923	3,337 109,461	5,268 172,814	11,984 393,129
150 (0.8600)	264 9,449	455 16,272	1,033 36,927	1,789 63,943	4,002 143,067	6,318 225,869	14,373 513,823
200 (1.1219)	302 10,792	520 18,589	1,180 42,175	2,043 73,030	4,571 163,400	7,216 257,971	16,415 586,851
300 (1.6480)	366 13,080	630 22,530	1,430 51,117	2,476 88,514	5,540 198,044	8,746 312,667	19,896 711,276
400 (2.1760)	420 15,030	724 25,889	1,643 58,736	2,845 101,709	6,365 227,567	10,050 359,276	22,862 817,305
500 (2.7054)	469 16,759	807 28,866	1,832 65,493	3,172 113,408	7,098 253,742	11,206 400,602	25,491 911,316
Air Minimum and Maximum Flow Rates (NCMM ⁴)							
Pressure ⁵ (Density) ⁶	80mm	100mm	150mm	200mm	300mm	400mm	600mm
0 (1.2238)	2 25	4 47	8 97	14 167	32 374	50 591	115 1,345
3.4 (5.3950)	4 109	8 204	17 426	30 738	67 1,650	106 2,605	241 5,926
6.9 (9.5774)	6 193	11 366	23 756	40 1,309	89 2,929	141 4,624	321 10,520
11.0 (14.6089)	7 260	14 492	28 1,018	49 1,762	110 3,942	174 6,224	396 14,159
13.8 (17.9711)	8 289	15 546	32 1,129	55 1,954	122 4,372	193 6,903	439 15,704
20.7 (26.3985)	10 350	19 662	38 1,368	66 2,369	148 5,299	234 8,367	532 19,033
27.6 (34.8562)	11 402	21 761	44 1,572	76 2,722	170 6,089	269 9,614	612 21,870
34.5 (43.3364)	13 448	24 848	49 1,753	85 3,035	190 6,790	300 10,720	682 24,386

- Standard conditions of 60 °F and 14.7 psia in schedule 40 pipe.
- psig
- lb/ft³
- Standard conditions of 15 °C and 1.013 bar in schedule 40 pipe.
- barg
- kg/m³

Saturated Steam Minimum and Maximum Flow Rates (lb/h ¹)							
Pressure ² (Density) ³	3"	4"	6"	8"	12"	16"	24"
0 (0.0373)	252 2,069	435 3,563	987 8,087	1,709 14,004	3,823 31,333	6,035 49,468	13,729 112,534
50 (0.1496)	506 8,297	871 14,287	1,976 32,425	3,421 56,148	7,654 125,627	12,085 198,336	27,491 451,189
100 (0.2570)	663 14,250	1,141 24,538	2,589 55,688	4,483 96,431	10,031 215,758	15,837 340,632	36,027 774,893
150 (0.3630)	787 20,116	1,356 34,640	3,076 78,613	5,327 136,129	11,919 304,577	18,817 480,858	42,805 1,093,889
200 (0.4682)	894 25,957	1,540 44,698	3,494 101,439	6,051 175,654	13,539 393,013	21,374 620,477	48,624 1,411,504
300 (0.6794)	1,077 37,667	1,855 64,862	4,209 147,200	7,289 25,895	16,309 507,308	25,748 900,386	58,574 2,048,260
400 (0.8930)	1,235 44,149	2,127 76,024	4,826 172,531	8,357 298,759	18,698 668,452	29,520 1,055,332	67,154 2,400,742
500 (1.1102)	1,377 49,228	2,371 84,770	5,381 192,380	9,318 333,129	20,849 745,351	32,916 1,176,739	74,879 2,676,927
Saturated Steam Minimum and Maximum Flow Rates (kg/h ⁴)							
Pressure ⁵ (Density) ⁶	80mm	100mm	150mm	200mm	300mm	400mm	600mm
0 (0.5980)	114 938	216 1,773	448 3,668	775 6,352	1,734 14,212	2,737 22,438	6,227 51,045
3.4 (2.3730)	230 3,763	431 7,037	896 14,708	1,552 25,468	3,472 56,983	5,482 89,964	12,470 204,656
6.9 (4.1190)	301 6,464	568 12,216	1,174 25,260	2,033 43,740	4,550 97,866	7,184 154,508	16,342 351,485
11.0 (6.1340)	367 9,655	693 18,191	1,435 37,731	2,486 65,336	5,561 146,186	8,780 230,793	19,973 525,024
13.8 (7.5040)	406 11,774	766 22,254	1,585 46,012	2,745 79,675	6,141 178,268	9,695 281,444	22,055 640,247
20.7 (10.8900)	489 17,085	923 32,294	1,909 66,769	3,306 115,618	7,398 258,687	11,679 408,408	26,569 929,075
27.6 (14.3100)	560 20,026	1,058 37,839	2,189 78,259	3,791 135,515	8,481 303,205	13,390 478,690	30,461 1,088,958
34.5 (17.8000)	625 22,329	1,180 42,193	2,441 87,262	4,227 151,105	9,457 338,085	14,930 533,760	33,965 1,214,233

- Standard conditions of 60 °F and 14.7 psia in schedule 40 pipe.
- psig
- lb/ft³
- Standard conditions of 15 °C and 1.013 bar in schedule 40 pipe.
- barg
- kg/m³

Measurable Flow Rates

Natural Gas Minimum and Maximum Flow Rates (SCFM ¹)							
Pressure ² (Density) ³	3"	4"	6"	8"	12"	16"	24"
0 (0.0457)	102 924	175 1,588	398 3,611	690 6,253	1,543 13,991	2,437 22,089	5,543 50,250
50 (0.2067)	217 4,184	368 7,044	848 16,352	1,468 28,315	3,284 63,352	5,185 100,019	11,795 227,529
100 (0.3695)	290 7,478	492 12,588	1,133 29,223	1,962 50,603	4,390 113,221	6,931 178,750	15,768 406,634
150 (0.5350)	341 10,590	588 18,236	1,334 41,384	2,309 71,662	5,166 160,338	8,157 253,137	18,555 575,854
200 (0.7030)	400 14,227	679 23,945	1,563 55,600	2,707 96,279	6,056 215,417	9,561 340,094	21,749 773,669
300 (1.475)	488 17,455	829 29,623	1,908 68,212	3,304 118,117	7,392 264,278	11,671 417,235	26,550 949,156
400 (1.4036)	565 20,204	959 34,286	2,209 78,958	3,824 136,725	8,557 305,912	13,510 482,965	30,732 1,098,683
500 (1.7715)	635 22,698	1,077 38,513	2,481 88,705	4,297 153,603	9,613 343,676	15,177 542,586	34,526 1,234,312

- Standard conditions of 60 °F and 14.7 psia in schedule 40 pipe.
- psig
- lb/ft³
- Standard conditions of 15 °C and 1.013 bar in schedule 40 pipe.

Natural Gas Minimum and Maximum Flow Rates (NCMM ⁴)							
Pressure ⁵ (Density) ⁶	80mm	100mm	150mm	200mm	300mm	400mm	600mm
0 (0.7320)	3 25	5 47	11 97	18 167	14 374	65 591	148 1,345
3.4 (3.3110)	6 112	11 205	23 438	39 758	88 1,695	139 2,676	316 6,088
6.9 (5.9188)	8 200	14 371	30 782	53 1,354	117 3,030	185 4,783	422 10,881
11.0 (9.1033)	10 308	18 569	38 1,203	65 2,083	146 4,660	230 7,357	523 16,735
13.8 (11.2610)	11 381	20 706	42 1,488	72 2,576	162 5,764	256 9,101	582 20,703
20.7 (16.7794)	13 467	24 873	51 1,825	88 3,161	198 7,072	312 11,165	710 25,399
27.6 (22.4835)	15 541	28 1,010	59 2,113	102 3,659	229 8,186	362 12,924	822 29,400
34.5 (28.3767)	17 607	32 1,135	66 2,374	115 4,110	257 9,196	406 14,519	924 33,029

- barg
- kg/m³
- Approximate specific gravity of natural gas = 0.61 and 0.8% N₂.

Straight Run Piping Requirements

	Upstream	Downstream
One 90° elbow before the meter	10 D	5 D
Two 90° elbows before the meter	15 D	5 D
Two 90° elbows out of plane before the meter	30 D	5 D
Reduction before the meter	10 D	5 D
Regulator or valve partially closed before the meter	30 D	5 D

D is equal to the internal diameter of the pipe.
If there is not sufficient straight run of pipe, a flow rectifier can be used to reduce the above lengths. Consult your local representative or the factory for your application.

Other Installation Considerations

Tap Size

1.875 in. (47.6 mm) minimum diameter.

Mounting Position

V-Bar probes may be installed in vertical, horizontal, or angled pipe sections. The meter is attached perpendicular to the axis of the pipe and should not be mounted "upside-down" (with its top section hanging below the pipe mount). For liquid service, the fluid must completely fill the pipe.

Site Selection

The flow measurement location should be selected to minimize turbulence and swirl. The extent of these flow disturbances depends upon the piping configuration. Valves, elbows, pumps, and other piping components may add disturbances to the flow.

Hot Tap Compatibility

The V-Bar-600/60S is hot tap compatible, which means that the sensor can be installed and removed under full flow conditions. The V-Bar-800/80S with flanged connection and V-Bar-910/960 are hot tap compatible when installed with a 2" double flanged, full port ball or gate valve that adheres to the dimensions of the gate valve on page 8.

Dimensions and Weights

V-Bar-600/60S

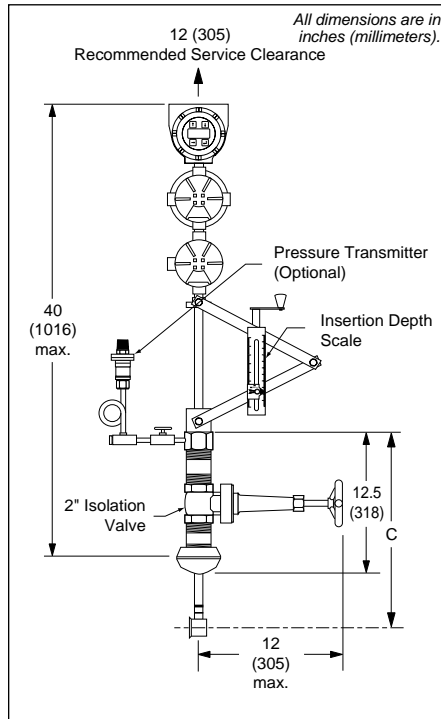

V-Bar-700

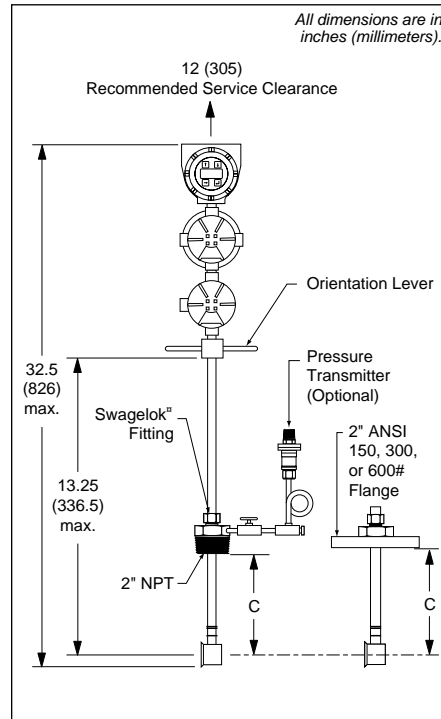

Dimension Tables

Model	Connection	C	
		in.	mm
600	2" NPT	4.5 min 18 max	114 min 457 max
700	2" NPT	3 min 10 max	76 min 254 max
	2" 150#	3 min 11.5 max	76 min 292 max
	2" 300#	3 min 11.25 max	76 min 285 max
	2" 600#	3 min 11 max	76 min 279 max
	2" 900#	3 min 10.75 max	76 min 273 max
800	2" NPT & 2" 150#	2 min 20 max	51 min 508 max

Model	Stem Length	B		A	
		in.	mm	in.	mm
910/960	Standard	1.5 _{min} 20 _{max}	38 _{min} 508 _{max}	30	762

V-Bar-800/80S

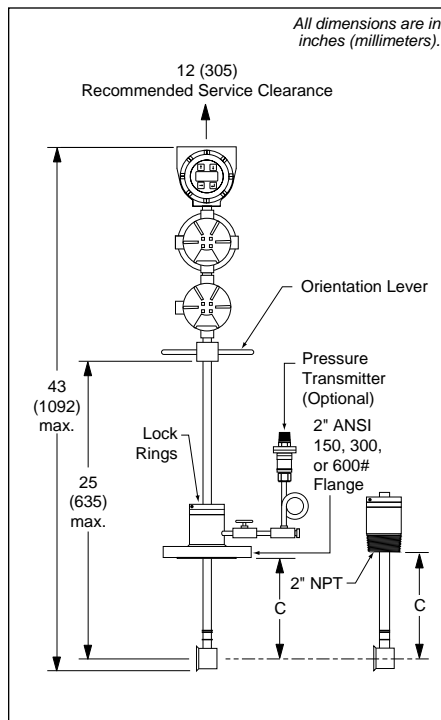

V-Bar-910/960

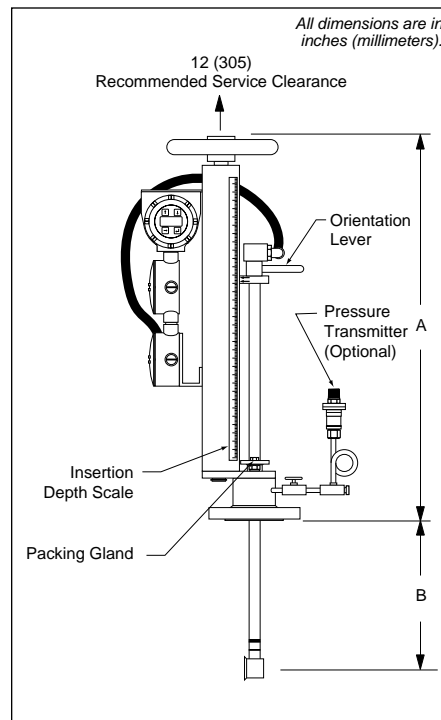

Weight

Model	Connection	Weight	
		lb	kg
60S	2" NPT	28 max.	12.7 max.
700	2" NPT	9	4.1
	2" 150#	12	5.4
	2" 300#	14	6.3
	2" 600#	16	7.2
	2" 900#	20	9.1
800/80S	2" NPT	11	5.0
	2" 150#	17	7.7
960	2" 150#	30	13.6
	2" 300#	35	15.8
	2" 600#	40	18.1
	2" 900#	47	21.3

Dimensions and Weights

Integral Electronics

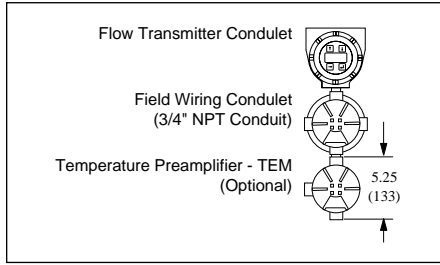

Pipe Mount Remote Electronics

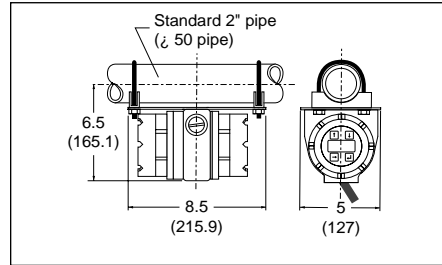

Gate Valve

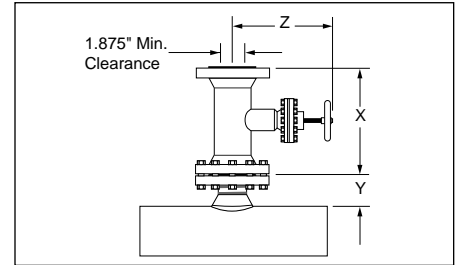

Gate valve is intended for use with the V-Bar-800/80S and V-Bar-910/960 only.

Remote Electronics Configuration

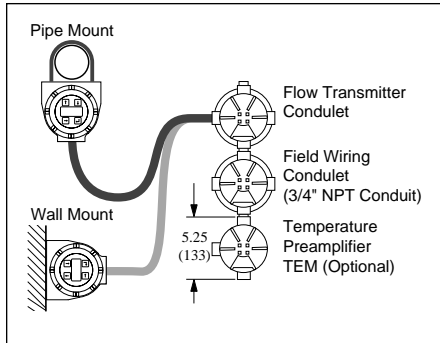

Pipe Mount Remote Electronics

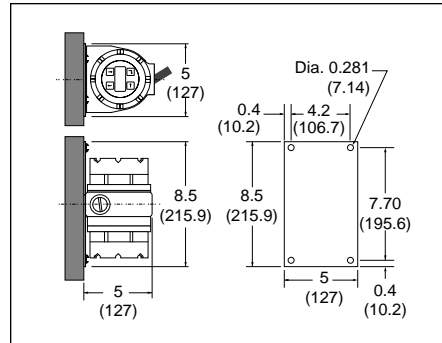

Type	X		Y		Z	
	in.	mm	in.	mm	in.	mm
150#	7	177.8	3.5	88.9	15.325	389.3
300#	8.5	215.9	3.75	95.3	16.325	414.7
600#	11.5	292.1	3.75	95.3	17.875	454.0

Type	lb	kg
2" 150#	46	20.9
2" 300#	58	26.3
2" 600#	84	38.1

All dimensions are in inches (millimeters).

For flange kit, add 14 pounds (6.4 kilograms) to weight.

Wiring Diagrams

VDC Power: Analog Output

Scalable 4–20 mA output, 2-wire principle. Load resistor may be installed on supply or return line. $V_s = 18\text{--}40$ VDC. See graph below for permissible R_{load} values.

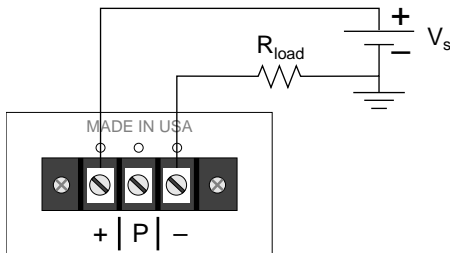

VAC Power: Analog Output

Scalable 4–20 mA output, 2-wire principle. Load resistor may be installed on supply or return line. $V_s = 110/220$ VAC. R_{load} must be less than 300 ohms.

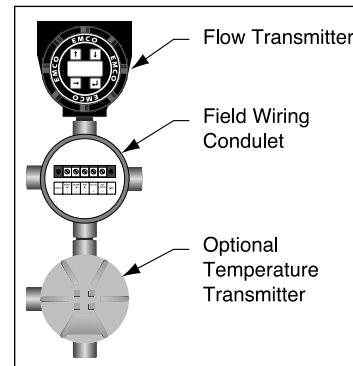
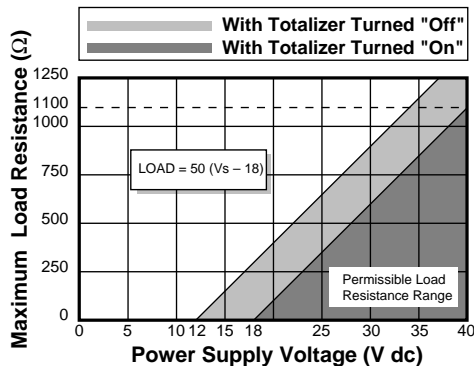

VDC Power: Pressure and Temperature Transmitter Wiring

Remove the field wiring conduit cap to access the field wiring terminal block for power and signal wiring. Flow, pressure, and temperature output wiring connects to the terminal block. Refer to the previous section on 24 VDC power and signal wiring for appropriate load resistance and power supply values. Pressure and temperature transmitters are scaled to the appropriate ranges at the factory.

Note: Maximum voltage with optional pressure transmitter is 30 VDC and

110/220 VAC power supply is not available with pressure and/or temperature transmitters.

Wiring with analog output:

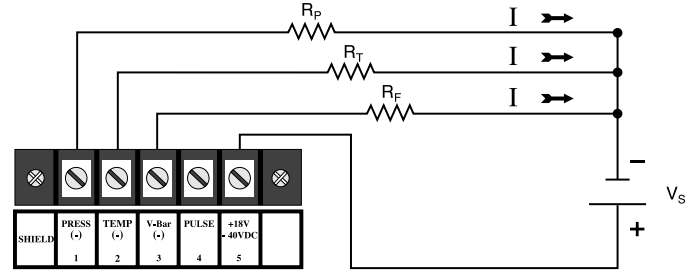

where:

$V_s = 18\text{--}30\text{ VDC}$

R_p = Pressure measuring resistance

R_t = Temperature measuring resistance

R_f = Flow rate measuring resistance

Remote Mount Wiring Diagram

Output wiring from remote electronics is identical to output wiring from integral electronics. Wiring from the remote electronics conduit to the electrical junction box must be performed in the field. Connect the remote cable to the terminal block in the junction box as shown. If nonconductive conduit is used, attach a ground strap from the ground screw on the remote electronics conduit. If the remote cable is cut to a shorter length, insulate shield with tape at electrical junction box.

Note: If remote mounting is required with a pressure and/or temperature transmitter, two power supplies are required for operation: one for the remote flow transmitter and one for the pressure and/or temperature transmitter.

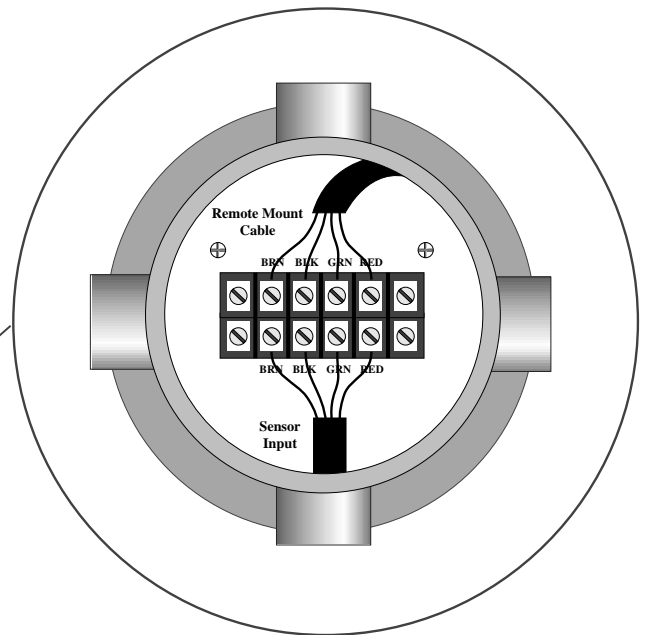
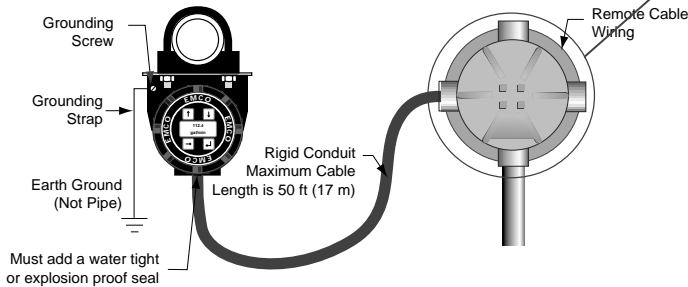

Customer Name

FLUID:

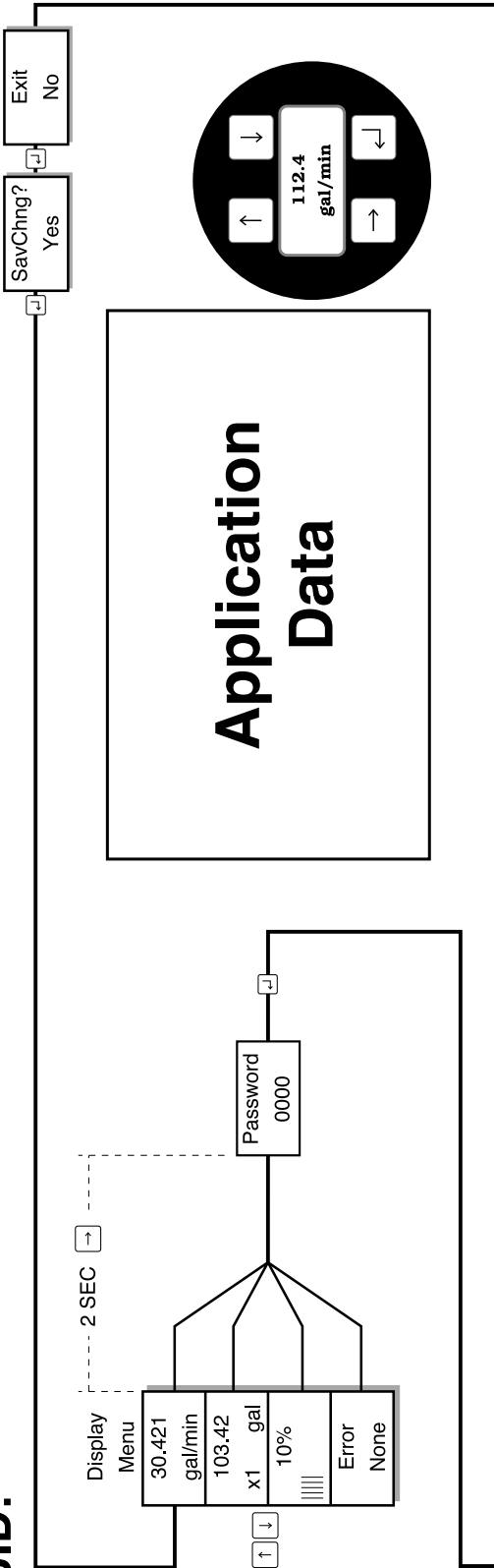

Work Order #

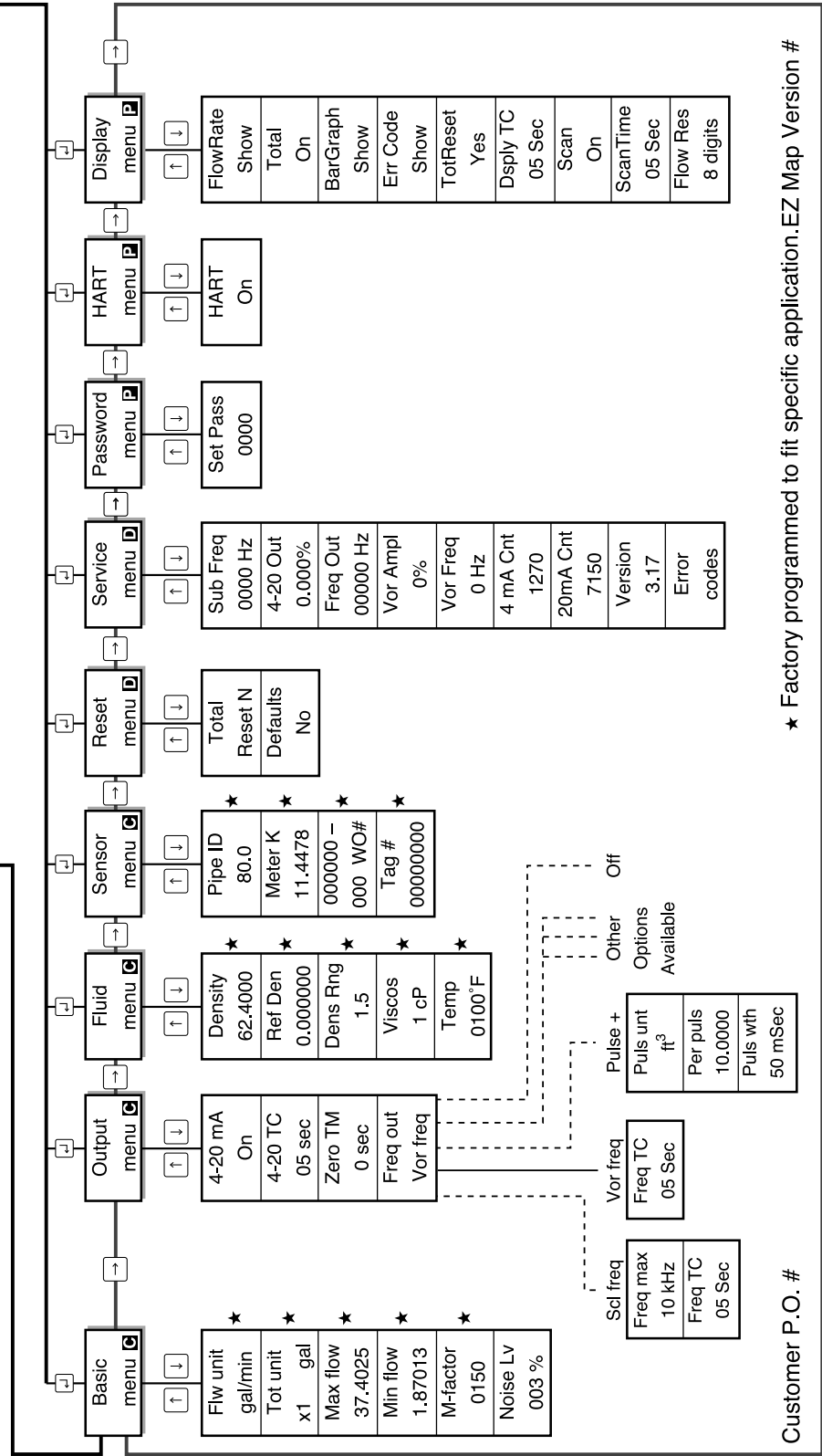

Model and Suffix Codes

Category	Description	Suffix Codes					
Model	Liquid or gas service, 400 °F (204 °C)	600
	Steam service, 400 °F (204 °C)	60S
	Liquid, gas, or steam service, 500 °F (260 °C)	700
	Liquid or gas service, 400 °F (204 °C)	800
	Steam service, 400 °F (204 °C)	80S
	Liquid, gas, or steam service, 400 °F (204 °C)	910
	Liquid, gas, or steam service, 500 °F (260 °C)	960
Connection	2", male NPT (model 700, 800, 80S)	...	2NPT
	2", 150# flange (model 700, 800, 80S, 910, 960)	...	2F150
	2", 300# flange (model 700, 910, 960)	...	2F300
	2", 600# flange (model 700, 910, 960)	...	2F600
	2", 900# flange (model 700, 910, 960)	...	2F900
	Thread-o-let, xx = 03-80 inches (models 600, 60S) includes 2" isolation valve	...	VXX
Pressure Transmitter	No pressure transmitter	XX
	PT for pressure range 0-50 psig (0-3.44 barg)	50
	0-100 psig (0-6.89 barg)	100
	0-150 psig (0-10.34 barg)	150
	0-200 psig (0-13.79 barg)	200
	0-250 psig (0-17.24 barg)	250
	0-500 psig (0-34.47 barg)	500
	0-1000 psig (0-68.95 barg)	1000
	Special scaling requests ¹	PXX
Temperature Sensor or Transmitter	No temperature transmitter	XXX
	Temperature sensor without preamplifier (RTD only)	RTD-T
	Teflon RTD internal wires -40 to 400 °F (-40 to 204 °C)	RTD-F
	Temperature sensor without preamplifier (RTD only)	RTD-F
	Fiberglass RTD internal wires 150 to 800 °F (65 to 427 °C) (models 700 and 960 only)	RTD-F
	Temperature sensor with preamplifier scaled from 32 to 68 °F (liquid/gas)	T09
	0 to 250 °F (liquid/gas)	T10
	-40 to 150 °F (liquid/gas)	T11
	212 to 400 °F (liquid/gas)	T12
	212 to 500 °F (steam) (model 700, 910, 960 only)	T14
	-17.7 to 121.1 °C (liquid/gas)	T20
	-40 to 65 °C (liquid/gas)	T21
	100 to 204 °C (steam)	T22
100 to 260 °C (liquid/gas) (model 700, 910, 960 only)	T24	
Special scaling requests ¹	TXX	
Electronics	EZ-Logic with local rate and total ²	LOC-TOT
	Remote mount electronics ³	RMT
	FM Approval ⁶	FM
	CSA Approval ⁷	CSA
	Integral 110 V ac input ^{4,5}	110
	Integral 220 V ac input ^{4,5}	220

Notes:

1. Special transmitter scaling is available. Please note scaling range below model code when ordering. If no special scaling is indicated, transmitter will be scaled per model code.
2. Unidirectional only. Unit has 4-20 mA and frequency output.
3. The standard remote option comes with 30 feet of cable.
4. Not available for use with pressure and temperature transmitters.
5. Not available with European CE Mark.
6. Certified by FM for Class I, Div. 2, Groups A, B, C, & D; Class II, III, Div. 2, Groups F & G; NEMA 4X. Not approved by FM when

- using a 4-20 mA temperature transmitter or a 110/220 VAC power supply option. If FM is required, use RTD option only for temperature selection. Pressure Transmitter 0–1000 psig or with special scaling not available with FM or CSA.
7. Certified by CSA for Class I, Div. 2, Groups A, B, C, & D; Class II, Div. 2, Groups F & G; Class III; Type 4X. Not approved by CSA when using a 4-20 mA temperature transmitter or a 110/220 VAC power supply option. If CSA is required, use RTD option only for temperature selection. Pressure Transmitter 0–1000 psig or with special scaling not available with FM or CSA.

Please specify the following information with your order:

- Fluid type or composition
- Maximum, minimum, and normal operating flow rate
- Maximum, minimum, and normal operating temperatures
- Maximum, minimum, and normal operating pressures
- Specific weight and viscosity at normal operating conditions

Providing innovative flowmeter products and services for over three decades . . .

Engineering Measurements Company (EMCO) is a long established manufacturer of precision flowmeters for liquid, gas, and steam applications for commerce and industry. Manufactured under an ISO 9001 certified quality system, which includes extensive flow calibration capability, engineering, applications, and service, underpinning a world-wide sales and service organization totally focused on providing the best flowmeters and customer service in the industry.

- ▶ Manufacturing is housed in a modern plant located in Longmont, Colorado
- ▶ Modern clean-room, mechanized assembly equipment, and computer based testing ensure the highest quality product
- ▶ Trained professional flow specialists and technicians offer timely customer assistance
- ▶ Factory trained and certified field technicians provide product support services

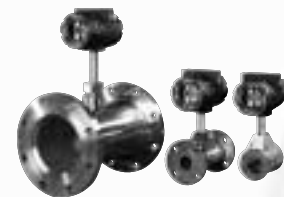

Vortex PhD™ Inline Vortex



V-Bar™
Insertion
Vortex



Turbo-Bar™
Insertion
Turbine



MAGFLO® Electromagnetic



PDH Helix



PDP Piston



Sono-Trak™



990101 Rev. K

Specifications subject to change without notice

Engineering Measurements Company

600 Diagonal Hwy. • Longmont, CO 80501 • (303) 651-0550 • Fax (303) 678-7152 • sales@emcoflow.com